

The R&D of the Fast MCP-PMTs for High Energy Physics Detectors

WWW.IHEP.CAS.CN



Sen.QIAN

qians@ihep.ac.cn; On Behalf of the FPMT R&D Group

The Institute of High Energy Physics, CAS

Outline

- 1. The Conventional PMTs
- 2. The 20 inch Large MCP-PMT (LPMT)
 - 2.1 The Design of LPMT;
 - 2.2 The Roadmap for the R&D of LPMT;
 - 2.3 The HPD LPMT for JUNO;
 - 2.4 The Fast LPMT for LHAASO;
- 3. The 2 inch Fast timing MCP-PMT (FPMT)
 - 3.1 The Roadmap for FPMT;
 - 3.2 The Performance of FPMT;
 - 3.3 The CTR of FPMTs;
 - 3.4 The Beam Test Results;
- 4. Summary

1.1 The Conventional -- Small-MCP-PMT

➤ The Microchannel Plate MCP

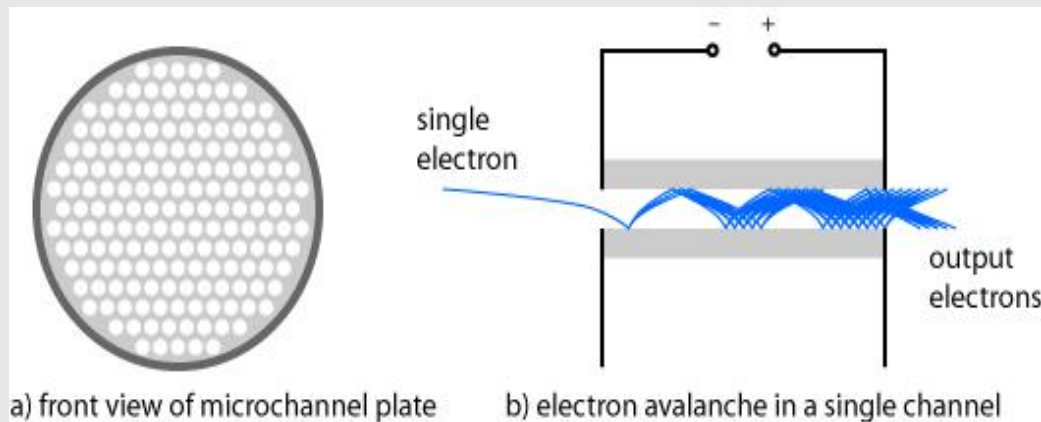

performance of the MCP:

- High Gain: 1×10^4 / 1 pic
- Small Size: Diameter=50mm
- Fast Signal: Rise time < 1ns
- TTS@SPE: ~30ps

➤ The Conventional small, fast timing MCP-PMT, FPMT

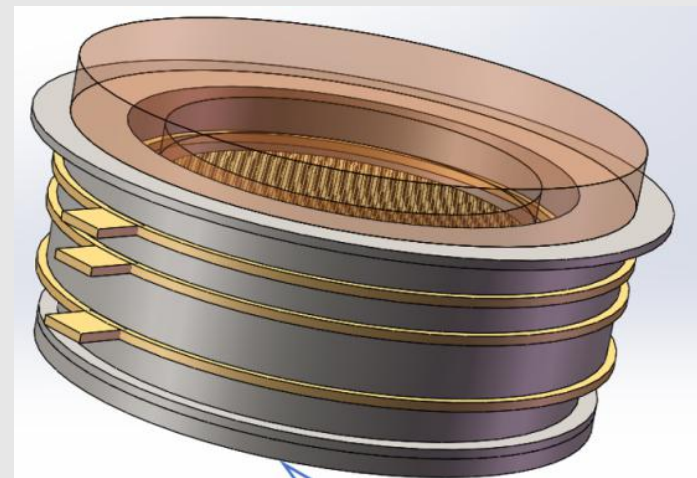
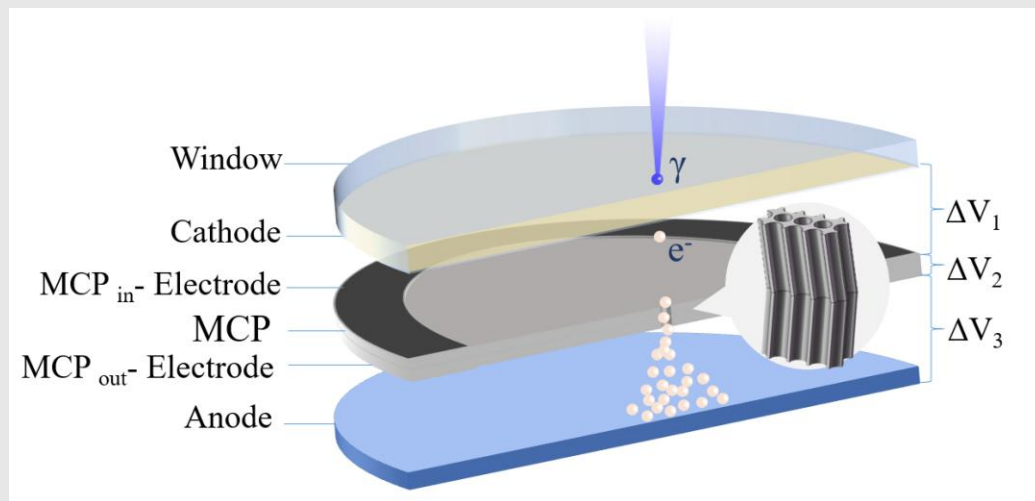

1.2 The Conventional -- Dysonde-PMT

➤ The 20 inch Dynode PMT

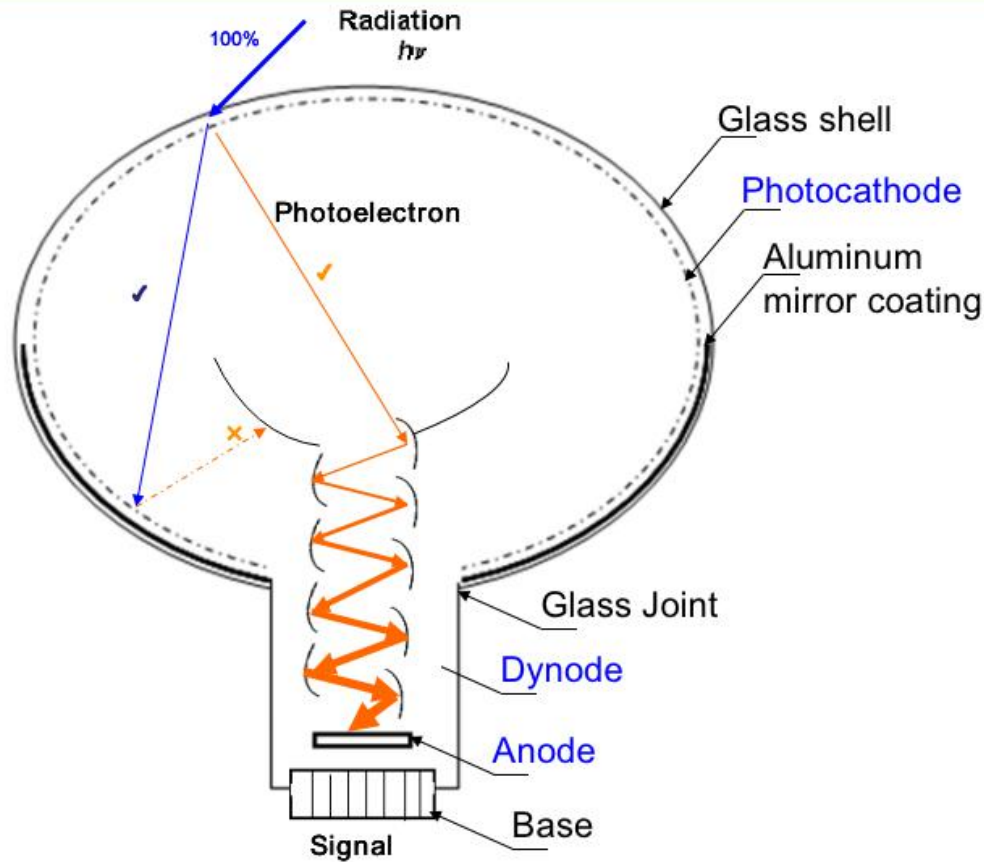

The first PMT in the world in 1933
"Kubetsky's tube"



How to improve the PDE of PMT?

Quantum Efficiency (QE) :

20%

Collection Efficiency (CE) of Anode:

70%

$$\text{Photon Detection Efficiency (PDE)} = \text{QE}_{\text{Trans}} * \text{CE} = 20\% * 70\% = 14\%$$

2.1 the design of a Large MCP-PMT (2009)

High photon detection efficiency + Single photoelectron Detection + Low cost

1) Using two sets of Microchannel plates (MCPs) to replace the dynode chain

2) Using transmission photocathode (front hemisphere) and reflection photocathode (back hemisphere)

~ 4π viewing angle!

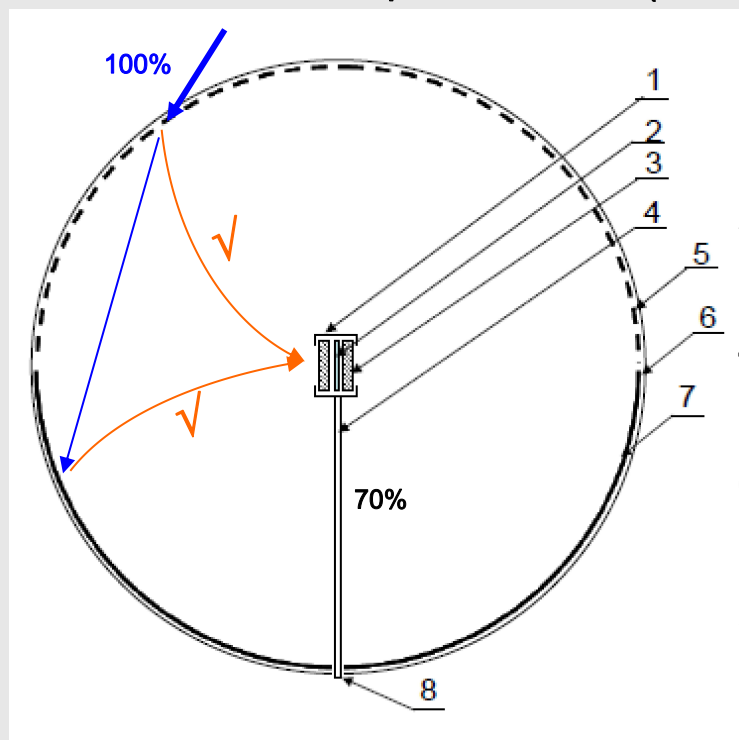

- 1. Insulated trestle table
- 2. Anode
- 3. MCP module
- 4. Bracket of the cables
- 5. Transmission Photocathode
- 6. Glass shell
- 7. Reflection Photocathode
- 8. Glass joint

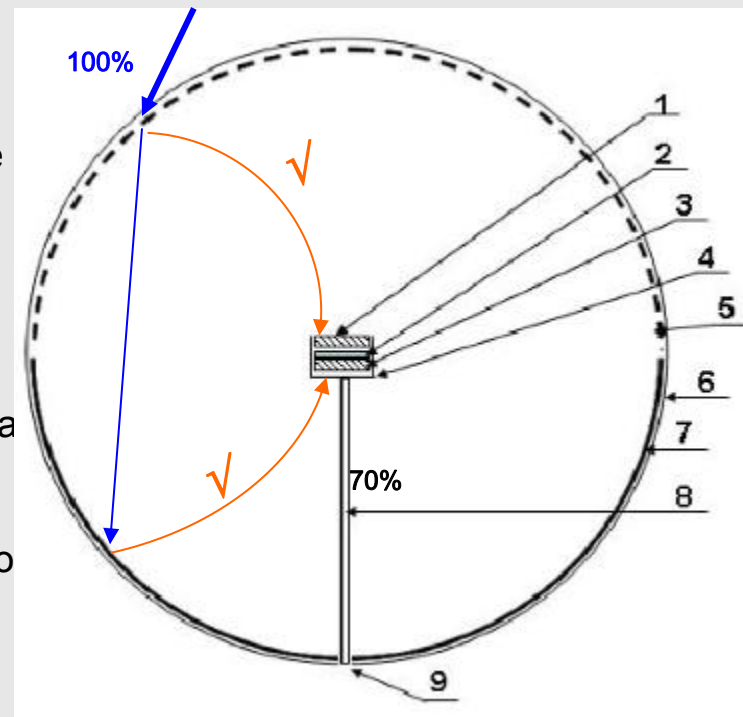

$$PD = QE_{Trans} * CE + TR_{Photo} QE_{Ref} * CE$$

Photon Detection Efficiency: 15% → 30% ; × ~2 at least !

2012 NIMA 695

2.2 The Roadmap -- (1) Technology

➤ Dynode-PMT

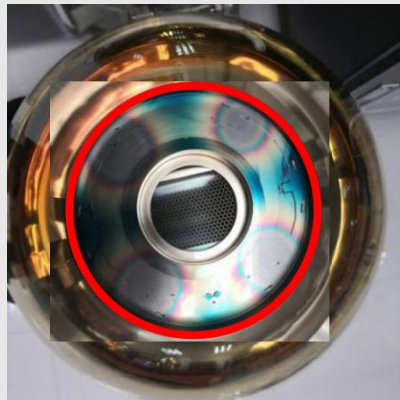
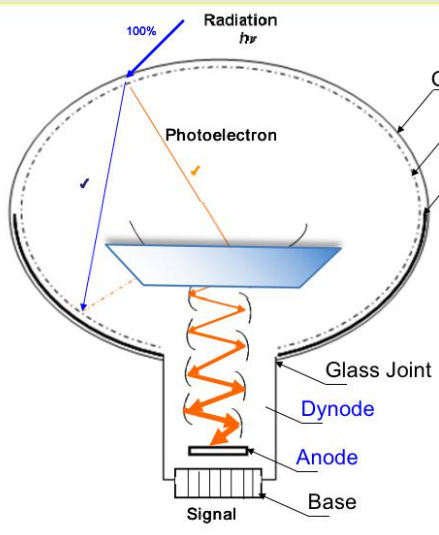

① MCPs for the SPE test

2016 NIMA 824

Quantum Eff.=20%

② QE=30%

2020 NIMA 971

- new tech. for the Photochade

Collection Eff.=70%

③ CE=100%

2017 NIMA 868

- ALD coating for the MCP

➤ MCP-PMT

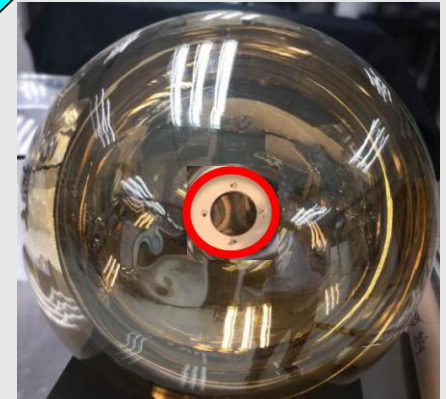
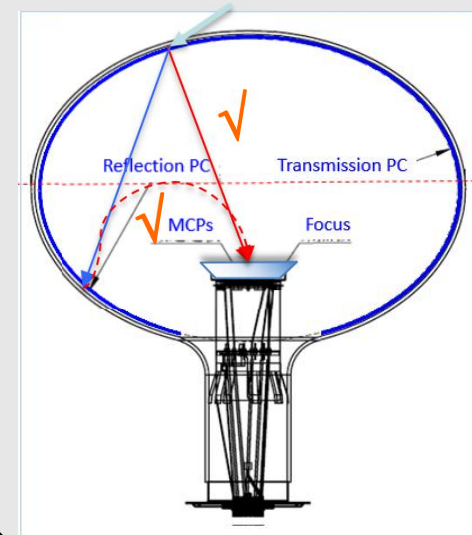

Detection Eff.=14%

④ DE=30%

2021 JINST 16 T05007

⑤ Low-Potassium Glass

2018 NIMA 898

⑥ Low cost (3000\$, 20KRMB)

2.2 The Roadmap -- (2) Parameters

Characteristics (20inch)	unit	MCP-PMT Prototype (IHEP)	MCP-PMTs 15K pieces (NNVT)
Electron Multiplier	--	MCP	MCP
Photocathode Mode	--	reflection+ transmission	reflection+ transmission
Quantum Efficiency (400nm)	%	26 (T), 30 (T+R)	32%
Collection Efficiency		~99%	99%
Detection Efficiency (400nm)	%	~ 27%	31.5%
Detection Efficiency (420nm)	%	--	28.3%
P/V of SPE		> 5	7.1
TTS on the top point	ns	~15	~ 20
Rise time/ Fall time	ns	R~2 , F~20	R~1.4 , F~24
Anode Dark Rate	Hz	~30K	40K
After Pulse Time distribution	us	0.1, 4.5	0.2 , 0.8 , 3 , 4.5, 17
After Pulse Rate	%	2.5%	5.2%
Glass	--	Low-Potassium Glass	Low-Potassium Glass

2.3 The High PDE 20" MCP-PMT for JUNO

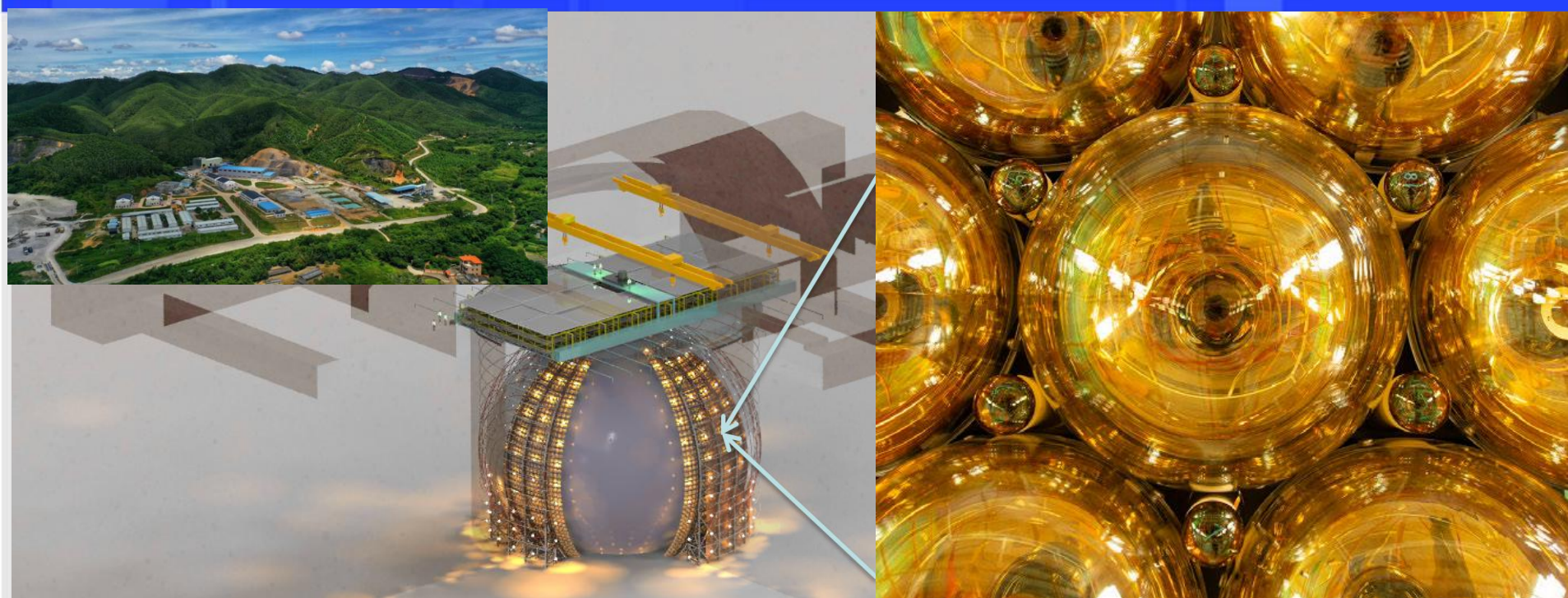

—JUNO (Jiangmen Underground Neutrino Observatory), has already supported the MCP-PMT collaboration group to R&D the 20 inch MCP-PMT from 2009 to 2020.

—Yifng Wang in IHEP is our group leader for this type of MCP-PMT development and the the company NNVT is the one to do the mass production work.

Parameters	MCP-PMT	Dynode-PMT
Total number	15000	5000
DE@420nm	28.3%	27.6%
Dark Rate	~ 40KHz	~ 17KHz
P/V	~7	~3

2020 NIMA 952;

2021 JINST 16 C11003

2.4 The FAST 20" MCP-PMT for LHAASO

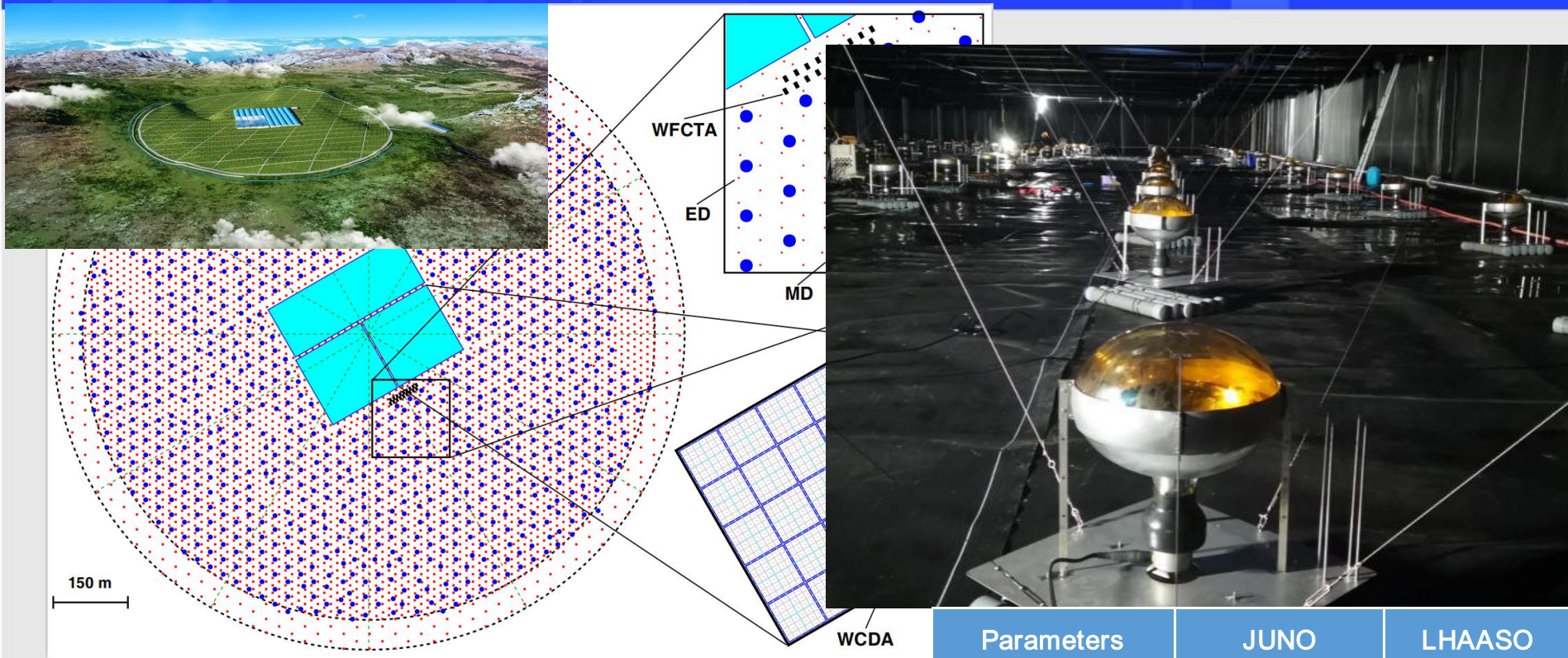

—LHAASO (Large High Altitude Air Shower Observatory), has already ordered 2270 pics 20" Flower-like-MCP-PMT.

—The 20 inch Prototype with potting has also post to the HyperK PMT Group in Tokyo University for the testing.

—The performance are different from the tubes for JUNO.

Parameters	JUNO	LHAASO
Total number	15000	2270
DE@400nm	30%	26.8%
Dark Rate	~ 40KHz	~ 15KHz
TTS	~20ns	~5.5ns

2020 NIMA 977;

Outline

- 1. The Conventional PMT's
- 2. The 20 inch MCP-PMT (LPMT)
 - 2.1 The Design of LPMT;
 - 2.2 The Roadmap for the R&D of LPMT;
 - 2.3 The HPD LPMT for JUNO;
 - 2.4 The Fast LPMT for LHAASO;
- **3. The Fast timing MCP-PMT (FPMT)**
 - 3.1 The Roadmap for FPMT;
 - 3.2 The Performance of FPMT;
 - 3.3 The CTR of FPMTs;
 - 3.4 The Beam Test Results;
- 4. Summary

3.1 The Roadmap for FPMT-- (1) Purpose

Operation Principle

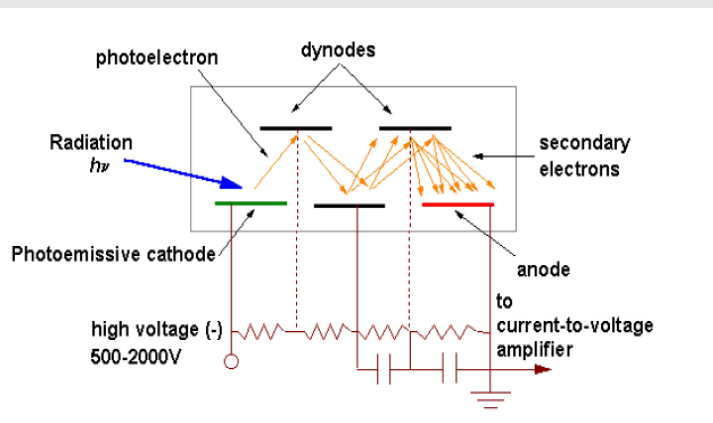

Small Size
(proximity focusing)

Large Size
(electrostatic focusing)

Dynode

2" Dynode-PMT ✓



20" Dynode-PMT ✓



MCP

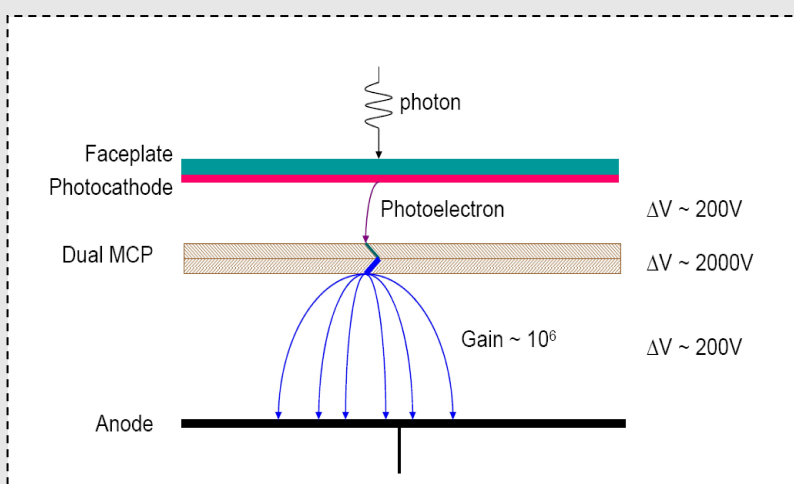

2" MCP-PMT ?

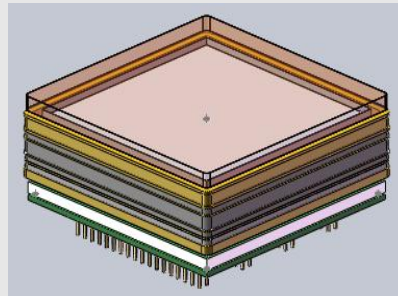

20" MCP-PMT ✓



3.1 The Roadmap for FPMT -- (2) Technology

- --Five Core technologies are needed to produce this new type of 2 inch Fast MCP-PMT;
- --We have the experience of the PC, MCP production, but need do more research on the sealing, the anode, and the electronics.

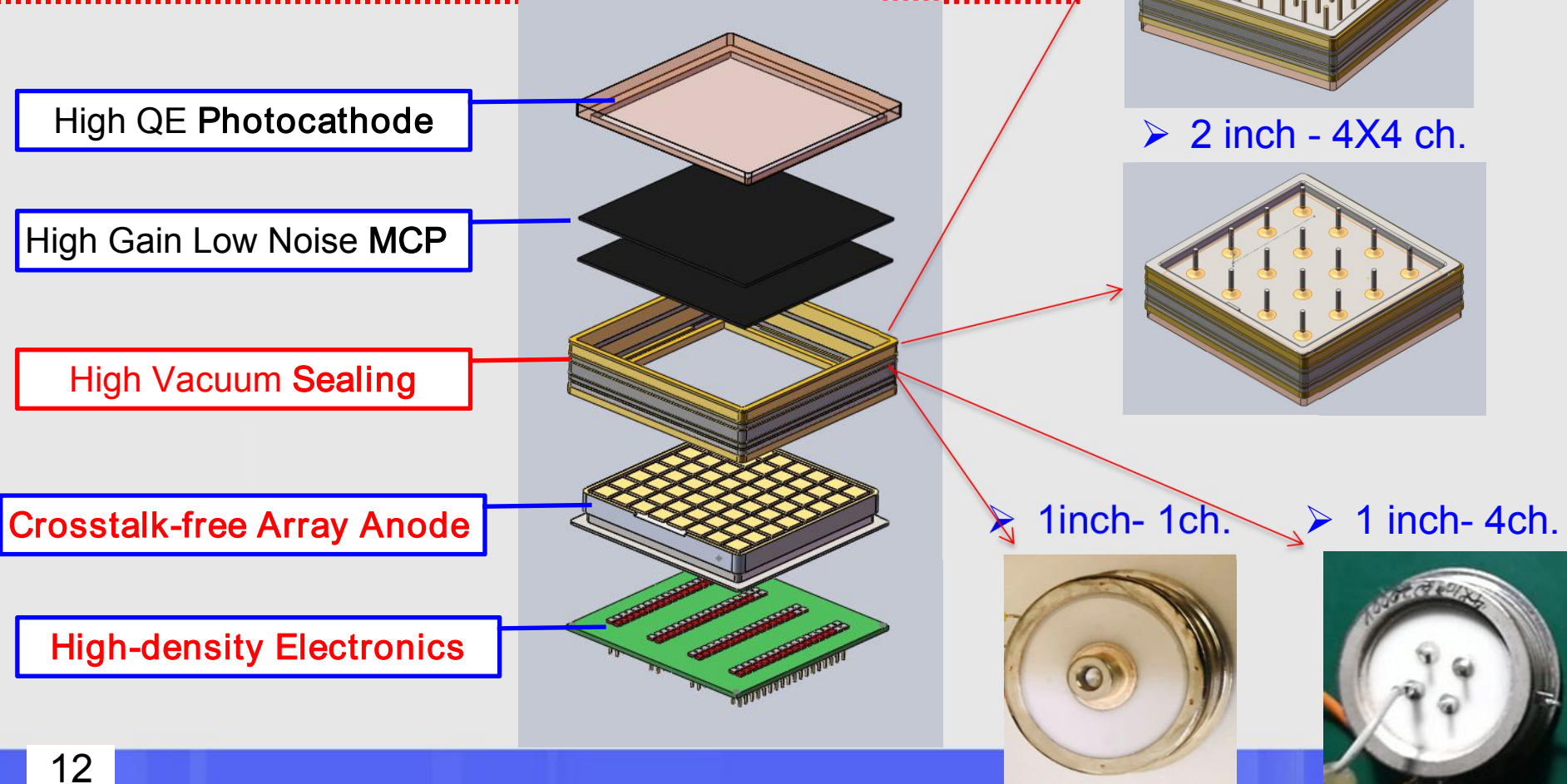

3.1 The Roadmap for FPMT -- (3) Prototypes



➤ Single Anode FPMT



➤ 2*2 Anodes FPMT



➤ 4*4 Anodes FPMT

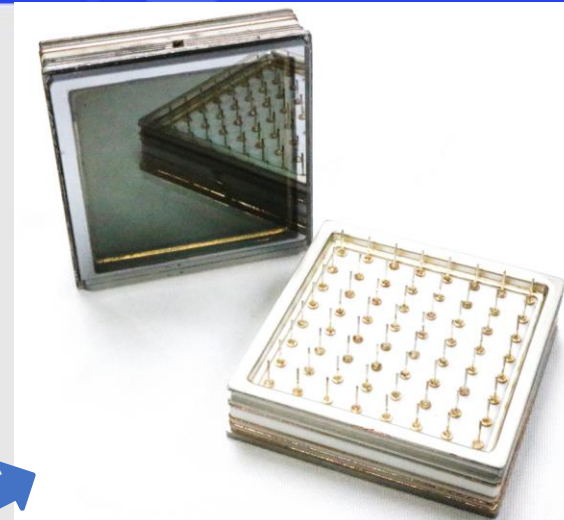

➤ 8*8 Anodes FPMT

FPMTs developed in IHEP+NNVT

3.2 The Performance -- (1) Single Anode FPMT

➤ Anode Optimization

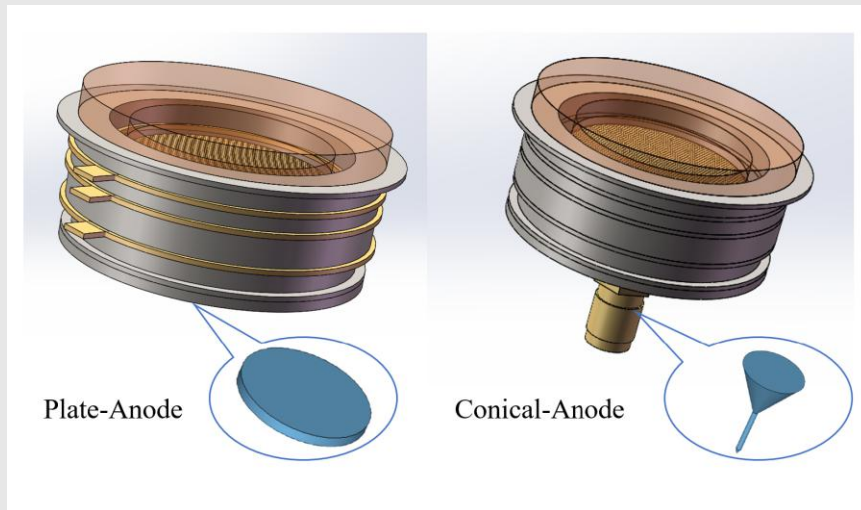

2022 NIMA 1041

➤ Waveform comparison

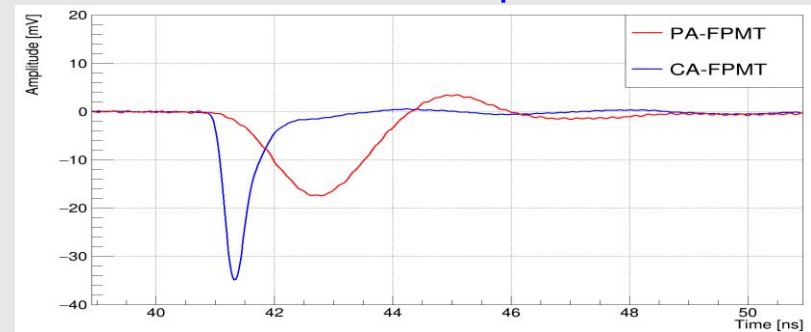

➤ SPE Spectrum

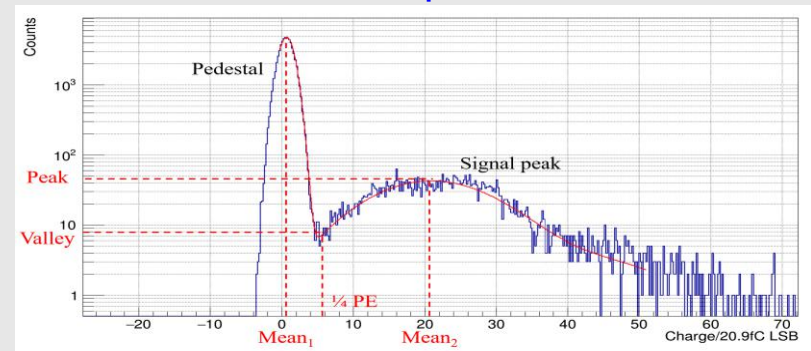

	HV/V	Gain	PV	Amp(SPE)	RT	FT	Width	TTS@SPE	TTS@MPE
Photek 210	-4700	2.9E6	2.0	93 mV	96 ps	350 ps	190ps	45 ps	10 ps
Plate-Anode	-2000	1.9E6	28.8	7 mV	1.4 ns	1.4 ns	1.8 ns	70 ps	25 ps
Conical-Anode	-3181	2.6E6	6.3	53 mV	150 ps	420 ps	330 ps	27 ps	5 ps

3.2 The Performance -- (2) 2X2 Anode FPMT

➤ 2*2 Anodes FPMT



➤ SPE Spectrum

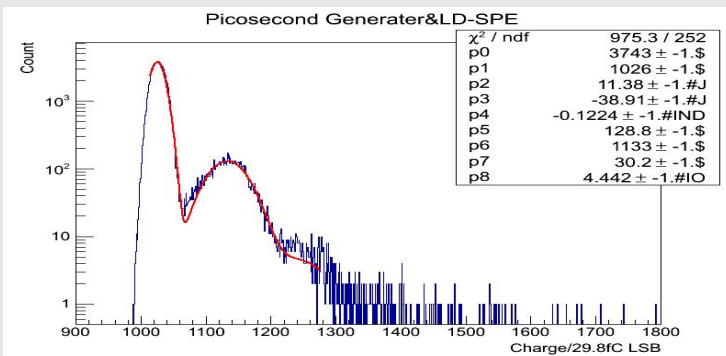

➤ Average waveform of SPE

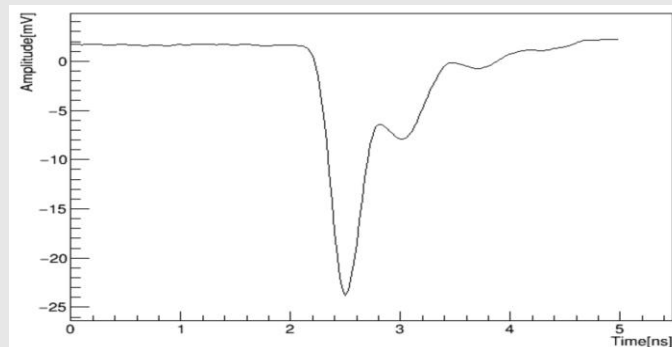

➤ SPE-TTS Spectrum

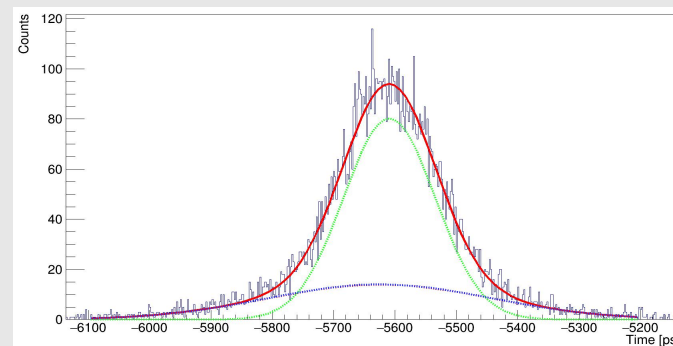

	HV/V	Gain	PV	Amp(SPE)	RT	FT	Width	TTS@SPE	TTS@MPE
Photek 210	-4700	2.9E6	2.0	93 mV	96 ps	350 ps	190 ps	45 ps	10 ps
2X2-Anode	-2500	1.9E6	6.5	34 mV	243 ps	516 ps	378 ps	67 ps	17 ps

Ref: Sen Qian, Oral report, The R&D of the Ultra Fast 8X8 Readout MCP-PMTs, ICHEP 2020

3.2 The Performance -- (3) 8X8 Anode FPMT



2022 JINST 17 T04002

➤ TTS Spectrum

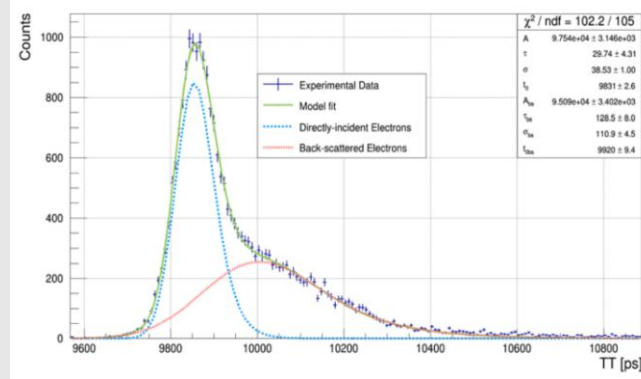

➤ TTS Variation with light intensity

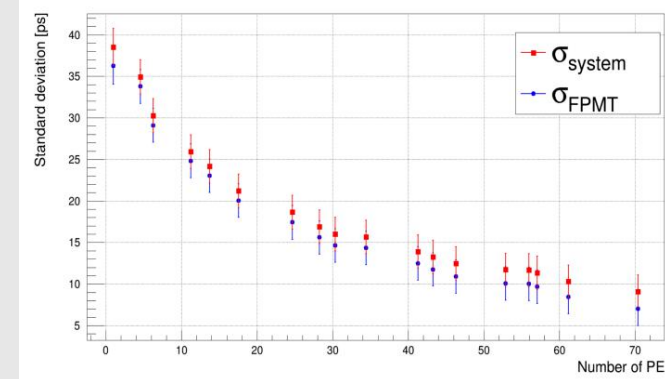

➤ Uniformity of Gain

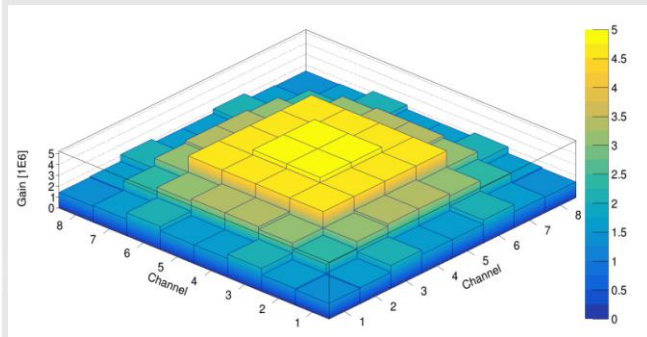

➤ Uniformity of P/V

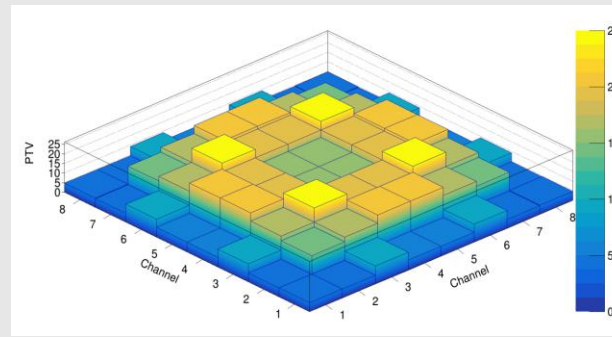

➤ Uniformity of TTS

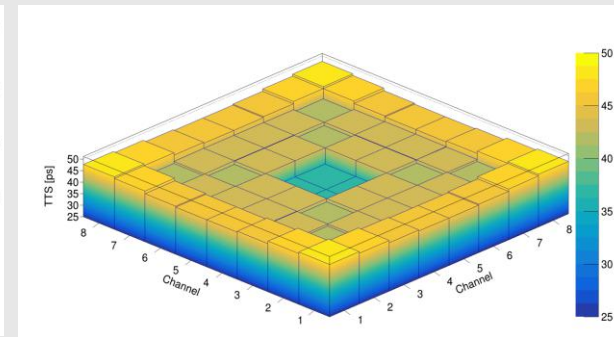

	HV/V	Gain	P/V	Amp(SPE)	RT	FT	Width	TTS@SPE	TTS@MPE
Photek-253	-2600	1.2E7	11.2	113 mV	490 ps	1.1 ns	~1ns	45 ps	16 ps
8*8 Anodes	-1500	3.9E6	18.6	45 mV	334 ps	660 ps	~900ps	40 ps	10 ps

3.3 The CTR of FPMTs

- ✓ Radioactive sources: Sodium (^{22}Na) ,
- ✓ Crystal: LYSO / Lead Fluoride (PbF_2)
- ✓ DAQ: Oscilloscope $\sim 25\text{ps}$
- ✓ FPMT: 1CH- Anodes FPMT*2

The Best Coincidence Time Resolution:

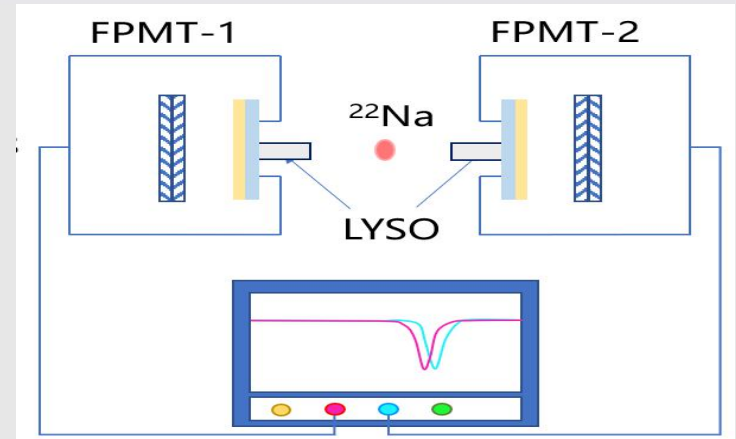

➤ CTR :FPMT+LYSO ($3*3*5\text{mm}^3$)

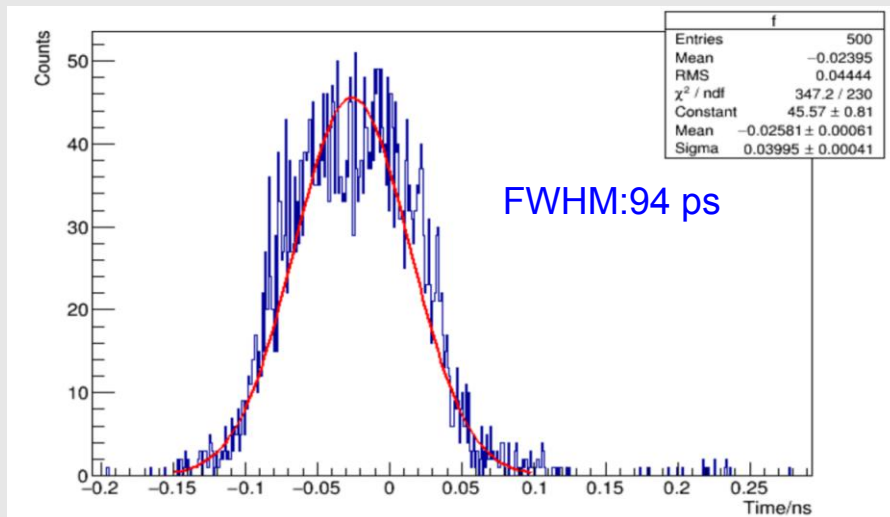

➤ CTR: FPMT+ PbF_2 ($3*3*5\text{mm}^3$)

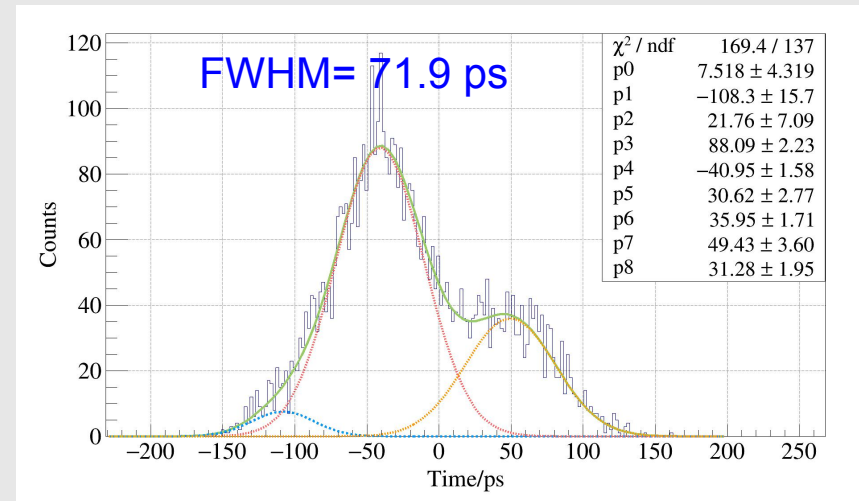

Ref: Lishuang Ma et al 2022 J. Phys.: Conf. Ser. 2374 012132

3.4 The Beam Test -- (1) Proton

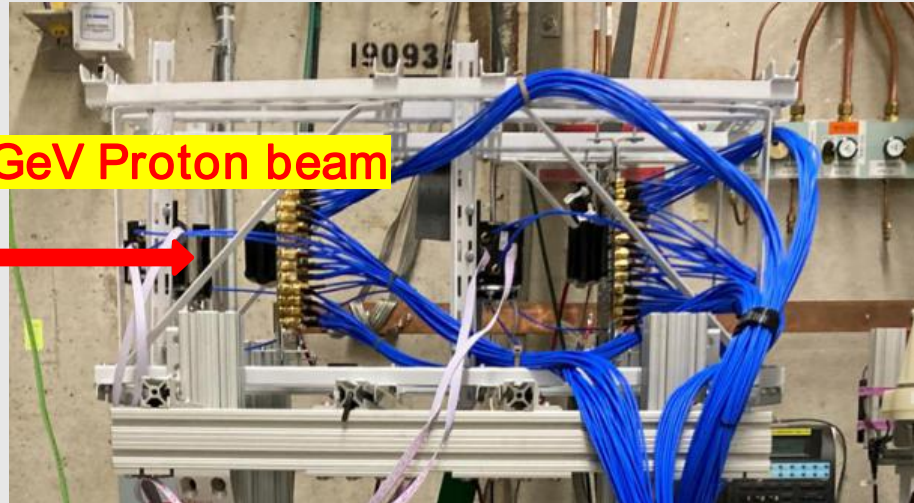

- Beam: 120GeV Proton (Fermi)
- Crystal: LYSO & BGO
- PMT: 8*8 FPMT
- DAQ: CAEN V1742~50ps;
- Carried out by Zhenyu Ye (UIC)
Zhihong Ye (THU)

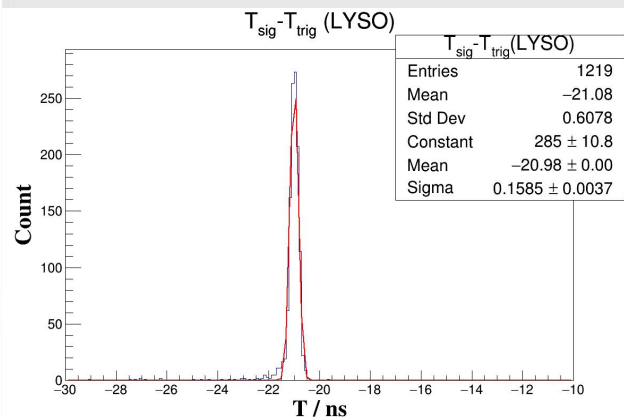

➤ LYSO single channel
Time Resolution
Sigma: 158.5 ps

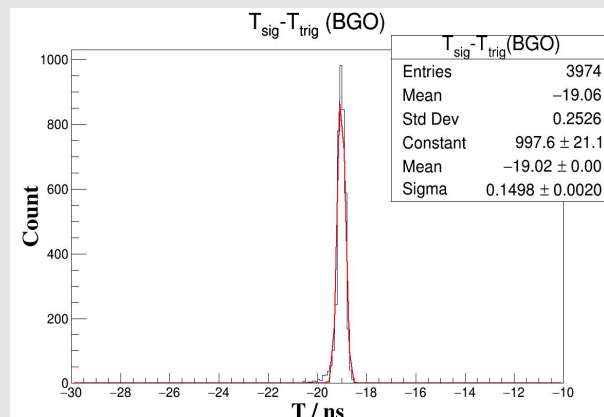

➤ BGO single channel
Time Resolution
Sigma: 149.8 ps

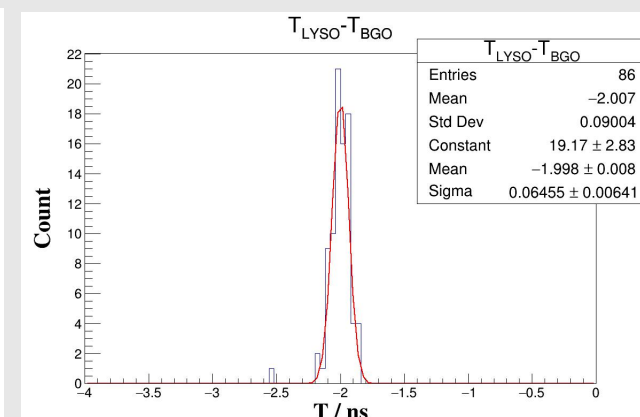

➤ LYSO & BGO
Coincidence Time jitter~64 ps
Single tube Time jitter ~45ps

3.4 The Beam Test -- (2) Muon

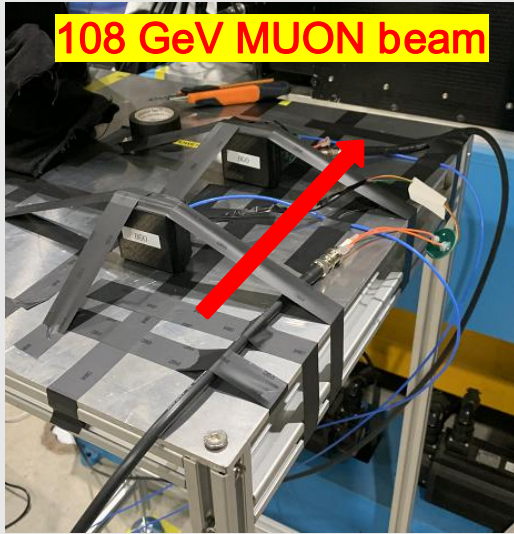

➤ Quartz Glass + FPMT

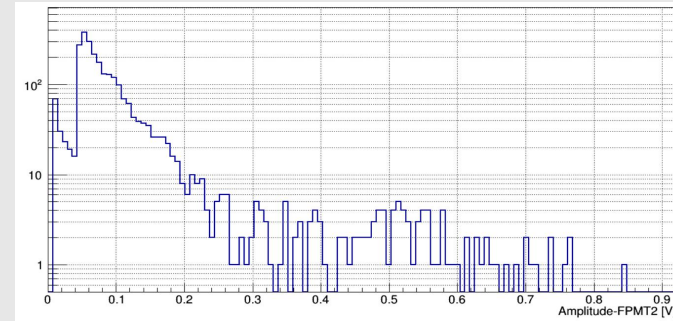
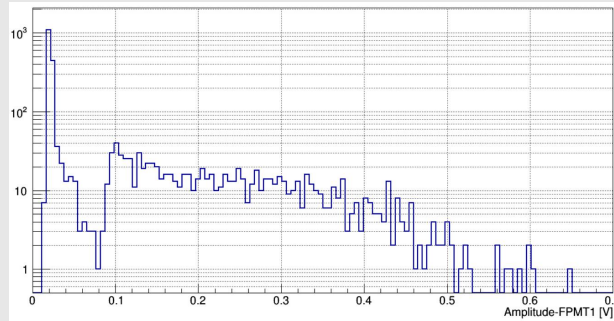

Coincidence time jitter ~ 56ps

Single tube Time jitter ~ 40ps

- **Beam:** (CERN)
108GeV Muon
- **Scintillator:**
Quartz Glass;
- **PMT:** 8*8 FPMT
TTS = 50ps@SPE;
- **DAQ:** 15 GSa/s ~ 25ps

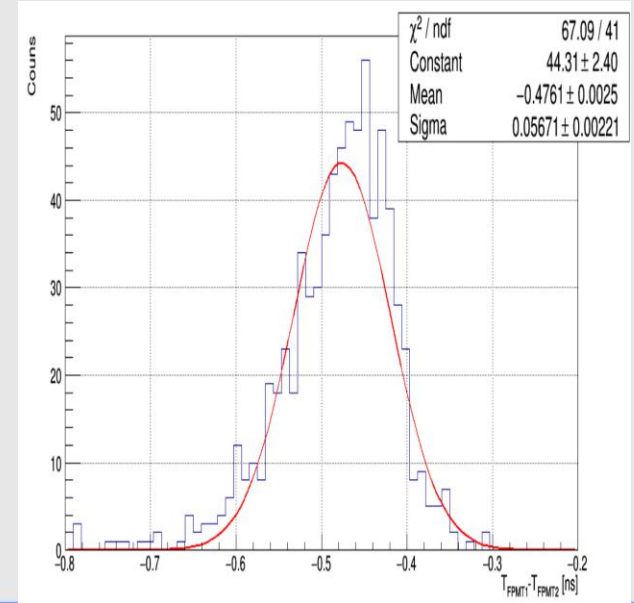
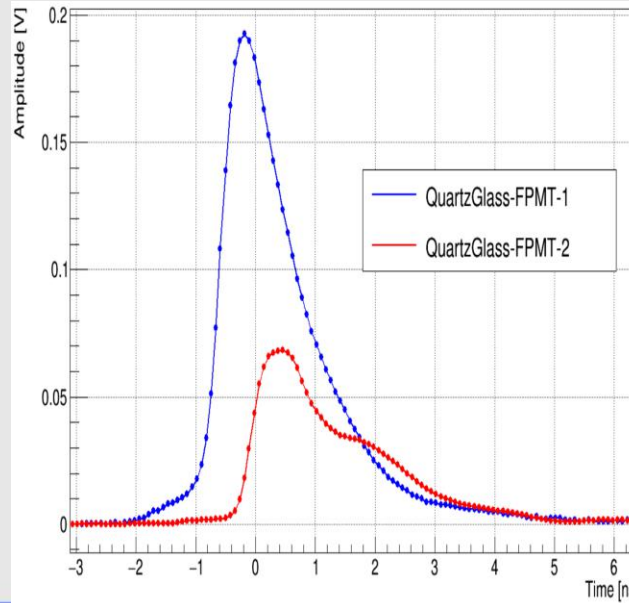

Outline

- 1. The Conventional PMT's
- 2. The 20 inch MCP-PMT (LPMT)
 - 2.1 The Design of LPMT;
 - 2.2 The Roadmap for the R&D of LPMT;
 - 2.3 The HPD LPMT for JUNO;
 - 2.4 The Fast LPMT for LHAASO;
- 3. The Fast timing MCP-PMT (FPMT)
 - 3.1 The Roadmap for FPMT;
 - 3.2 The Performance of FPMT;
 - 3.3 The CTR of FPMTs;
 - 3.4 The Proton Beam Test;
- 4. Summary

4. Summary-- (1) The PMTs

Operation Principle

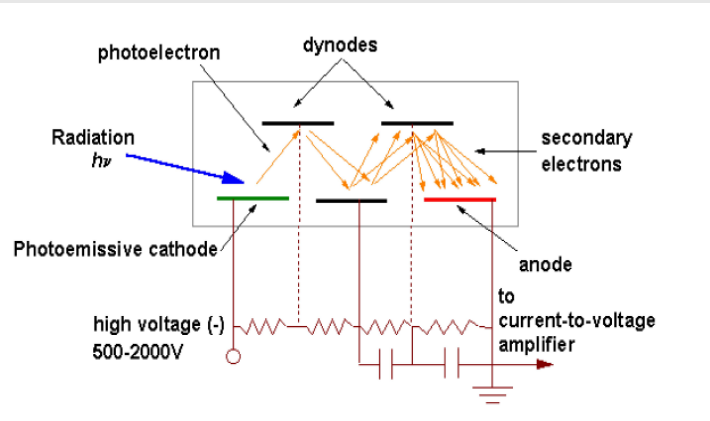

Small Size
(proximity focusing)

Large Size
(electrostatic focusing)

Dynode

2" Dynode-PMT ✓



20" Dynode-PMT ✓



MCP

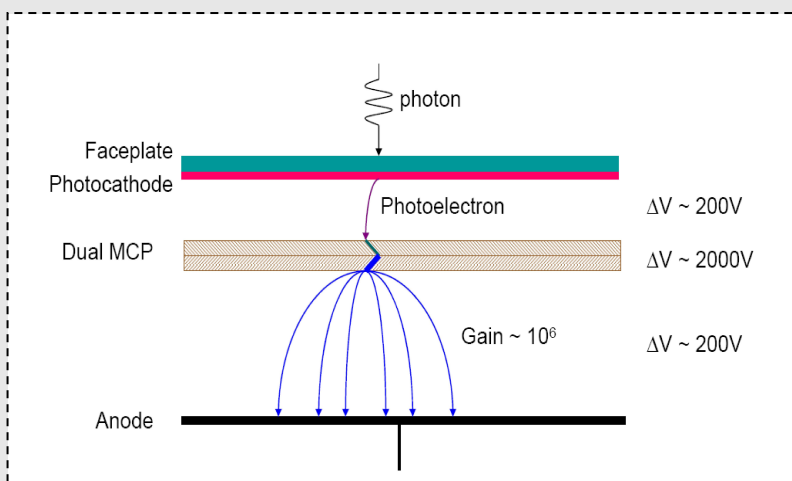

2" MCP-PMT ✓

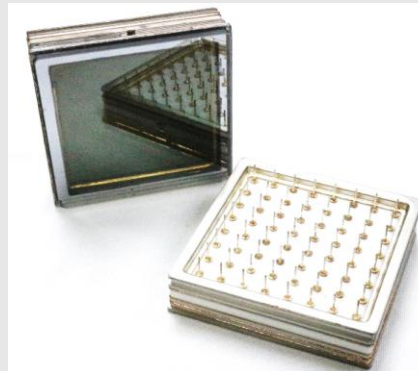

20" MCP-PMT ✓



4. Summary-- (2) The Group



Institute of High Energy Physics, CAS

Microchannel-Plate-Based Large Area Photomultiplier Collaboration (MLAPC)

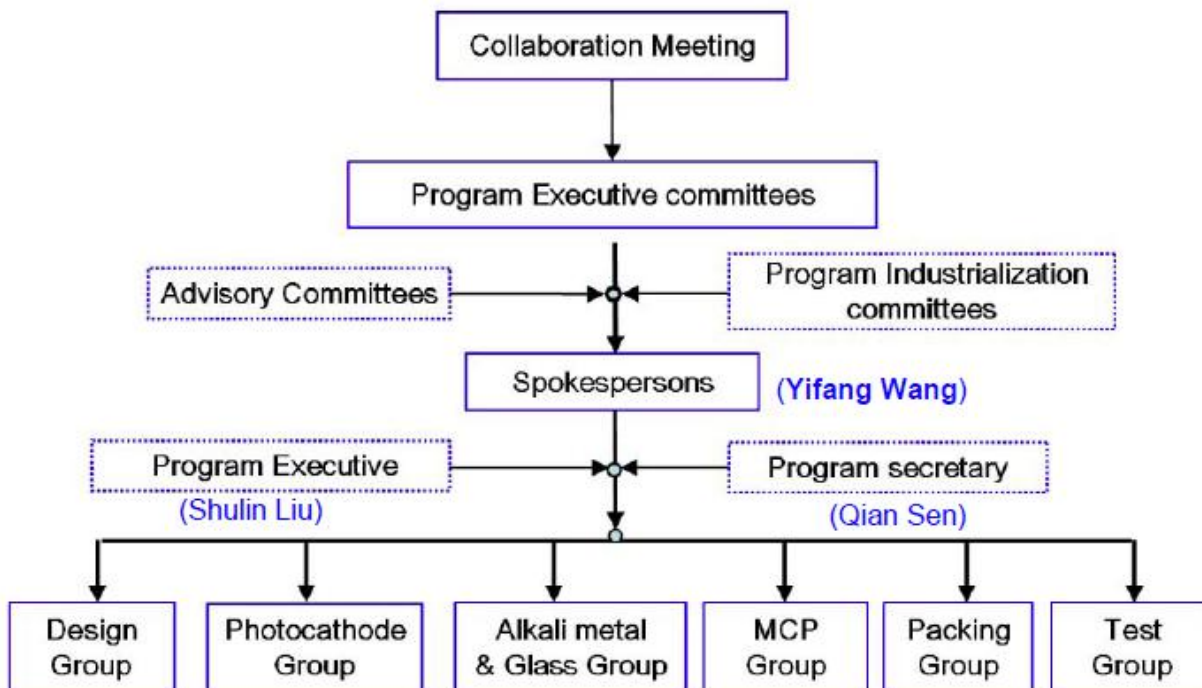

effort by Yifang Wang



4. Summary-- (3) The PMT Test Facility

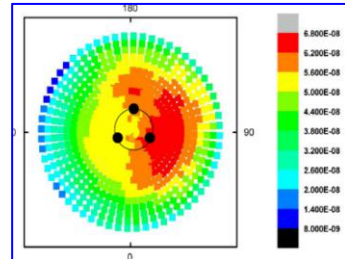
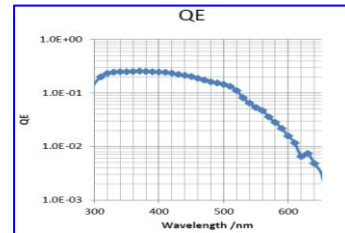
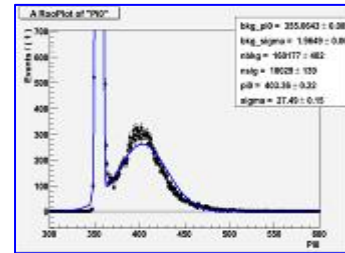
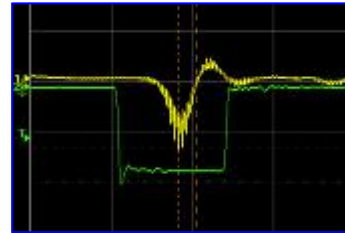
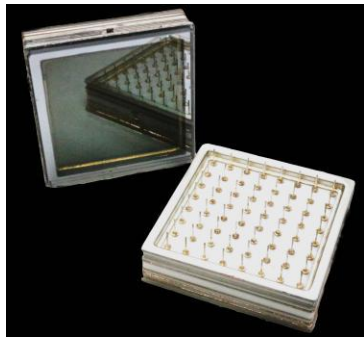

Others

.....

- Anode Pulse Rise Time;
- Pre/Late/After Pulse;
- Dark Count
- The Single Photoelectron Spectrum;
- The voltage distribution (BASE) ;
- The Supply voltage;
- Typical Gain Characteristic;
- Anode Dark Current
- Spectral Response;
- Wavelength of Maximum Response;
- Cathode Sensitivity: Luminous(2856K);
- Quantum efficiency with λ
- Photocathode efficiency Area;
- Photocathode efficiency Uniform;
- The position of the Sb, K, Cs;
- The linearity of the PMT
- Magnetic characteristics;
- Transit Time Spread (FWHM)

4. Summary--(4) The Photodetector Lab in IHEP

工欲善其事必先利其器 = Work must first of its profits

工欲善其事
必先利其器

二欲善其事，必先利其器。



工欲善其事
必先利其器

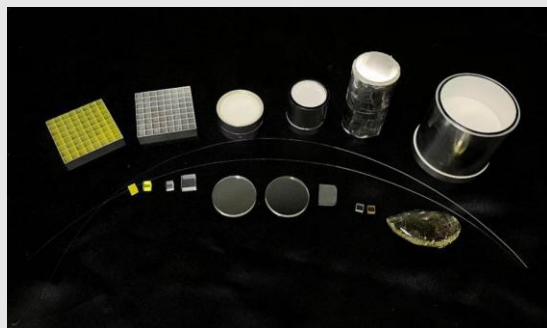

+



=

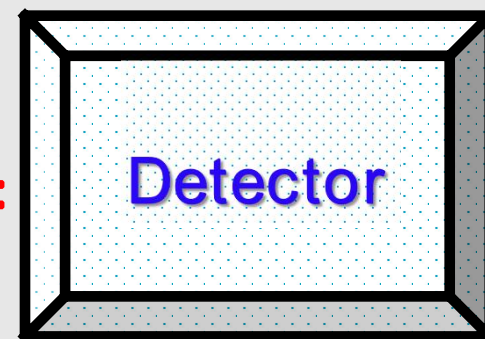

谢谢!



Thanks for your attention!

Any Comment & Suggestion are welcomed!



The PMT Family in NNVT in China

THANKS



See the unseen
change the unchanged



The Innovation